

Educational Product	
Educators	Grades 5–8



Investigating the Climate System

WINDS

Winds at Work



PROBLEM-BASED CLASSROOM MODULES



Responding to National Education Standards in:

English Language Arts ♦ Geography ♦ Mathematics
Science ♦ Social Studies



Investigating the Climate System



Authored by:

Phil Astwood, University of South Carolina, Columbia, SC

Prepared by:

Stacey Rudolph, Senior Science Education Specialist, Institute for Global Environmental Strategies (IGES), Arlington, Virginia

John Theon, Former Program Scientist for NASA TRMM

Editorial Assistance, Dan Stillman, Science Communications Specialist, Institute for Global Environmental Strategies (IGES), Arlington, Virginia

Graphic Design by:

Susie Duckworth Graphic Design & Illustration, Falls Church, Virginia

Funded by:

NASA TRMM Grant #NAG5-9641

Give us your feedback:

To provide feedback on the modules online, go to:

https://ehb2.gsfc.nasa.gov/edcats/educational_product

and click on "Investigating the Climate System."

NOTE: This module was developed as part of the series "Investigating the Climate System." The series includes five modules:

Clouds, Energy, Precipitation, Weather, and Winds. While these materials were developed under one series title, they were designed so that each module could be used independently. They can be freely downloaded at:

<http://www.strategies.org/CLASS.html>

June 2003

CONTENTS

Grade Levels; Time Required; Objectives;
Disciplines Encompassed; Key Terms;

Resources 2

Part 1: What determines where fish
are found in the ocean? 3

 Background; Activity One 3

 Activity Two; Activity Three 4

Part 2: How do upwelling zones form
in the equatorial area? 4

 Background 4

 Activity One; Activity Two; Activity Three 5

Part 3: What creates the winds that
control El Niño? 5

 Background 5

 Activity One; Activity Set Two 7

 Activity Three 8

Part 4: How do winds affect the ocean? 9

 Background 9

 Activity One; Activity Two; Activity Three 9

Part 5: Can the use of satellite data
improve your fishing results? 10

Appendix A: Bibliography 11

Appendix B: Assessment Rubric & Answer Keys 12

Appendix C: National Education Standards 15

Appendix D: Problem-Based Learning 17

Appendix E: TRMM Introduction/Instruments 19

Appendix F: Glossary 21

Investigating the Climate System

WINDS

Winds at Work



GRADE LEVELS

Grades 5–8

TIME REQUIRED

Three to five days for each of Parts 1–5

OBJECTIVES

- Define, identify and compare different trophic levels in the open ocean.
- Interpret the effects of temperature change and the Earth's rotation on water movement.
- Research and apply knowledge of the effect of winds on ocean currents.
- Demonstrate knowledge of upwelling.
- Build meteorological instruments and collect and apply data.
- Apply knowledge gained to worldwide ocean patterns.
- Identify the relationship between productivity in the open oceans and fish populations.
- Interpret TRMM satellite data.
- Apply TRMM satellite data to determine the location of fish populations in the open ocean.

DISCIPLINES ENCOMPASSED

Earth science, meteorology, physical oceanography, biology, mathematics, technology, English/language arts, geography

KEY TERMS

air pressure
barometer
banks
consumers
Coriolis effect
differential heating
divergence
downwelling
easterly trade winds
food chain
Gulf Stream
Hadley circulation
high pressure
low pressure

nutrients
photosynthesis
phytoplankton
polar easterlies
pressure gradient force
producers
Southern Oscillation
trade winds
trophic level
upwelling
westerly winds
wind belts
zooplankton

RESOURCES

American Oceans Campaign:

<http://www.americanoceans.org>

CERES instrument information: [http://eosweb.larc.](http://eosweb.larc.nasa.gov/PRODOCS/ceres/table_ceres.html)

[nasa.gov/PRODOCS/ceres/table_ceres.html](http://eosweb.larc.nasa.gov/PRODOCS/ceres/table_ceres.html)

Earth Observatory: <http://trmm.gsfc.nasa.gov>

Global Wind Patterns: <http://kids.earth.nasa.gov/archive/nino/global.html>

GSFC Scientific Visualization Studio:

<http://svs.gsfc.nasa.gov>

Marine Modeling and Analysis:

<http://polar.wwb.noaa.gov/omb/products.html>

NASA GOES Project Science:

<http://rsd.gsfc.nasa.gov/goes>

NASA TRMM Satellite: <http://trmm.gsfc.nasa.gov>

National Oceanographic Data Center:

<http://www.ngdc.noaa.gov>

Ocean Planet:

http://seawifs.gsfc.nasa.gov/ocean_planet.html

Ocean Surface Topography from Space:

<http://topex-www.jpl.nasa.gov/index.html>

Ocean World: <http://oceanworld.tamu.edu>

Pressure and Wind: <http://geology.csupomona.edu/drjessey/class/Gsc101/Pressure.html>

QuikSCAT mission information: <http://winds.jpl.nasa.gov/missions/quikscat/quikindex.html>

Terra: <http://terra.nasa.gov>

U.S. Bathymetric & Fishing Maps: <http://www.ngdc.noaa.gov/mgg/bathymetry/maps/nos.html>

Winds: Measuring Ocean Winds from Space:

<http://winds.jpl.nasa.gov>

SCENARIO You work for a fishing company that is seeking investors. You believe that one of your company's strengths is that you use TRMM data to locate fishing areas. You must convince the investors that this gives your company a significant advantage.

PART 1

What determines where fish are found in the ocean?

BACKGROUND

The location of fish in the open ocean is determined primarily by the temperature of the water and the availability of food. In a broad sense, the temperature of the water at the surface depends on the latitude—with warmer waters near the equator and colder waters at higher latitudes. Even at lower latitudes, however, cooler water and **nutrients** from deeper layers can be brought to the surface by an overturning process called **upwelling**. Cold water will hold more dissolved oxygen than warm water; as a result, many large and active fish seek the oxygen-rich cooler water. At the same time, however, because most chemical reactions proceed more slowly at low temperatures, the growth of plants and animals may be slower.

Because plants are at the base of the **food chain**, the rate at which they grow determines the rate at which all other living things can grow. To survive, plants require sunlight for energy and nutrients to build their structures. Nutrients are elements such as sulfur, potassium, and nitrogen that are essential for the growth of plants, but are not readily available in water. On land, plants can receive direct sunlight from above and derive most nutrients from the soil, where they have accumulated following the decay of prior generations of plants. In the ocean, dying organisms sink to the bottom and their decay products accumulate there, whereas sunlight can only penetrate the upper 200 meters of the ocean water. Thus, nutrients and sunlight may be separated vertically by thousands of meters.

As a result, ocean plants, such as microscopic **phytoplankton** (algae), near the ocean surface must depend on upwelling for the nutrients they need. The phyto-

plankton provide food for **zooplankton** (very small animals). The zooplankton are food for larger animals, that are food for even larger animals, and so on up the food chain. Each level in a food chain is referred to as a **trophic level**. The first trophic level is made up of **producers**, plants that can obtain energy directly from the sun via **photosynthesis**. The producers on the first level provide food for **consumers** on the next level that must obtain their energy by eating plants. Consumers on the third level obtain their energy by eating animals on the second level, and so on up the chain.

In this way, energy originally obtained from the Sun is passed from one trophic level to the next. However, the transfer is very inefficient, with only about 10% of the energy at one level making it to the next. As one might expect, this process is most efficient in upwelling areas where nutrients are abundant and an organism does not have to travel far to find food. Areas of upwelling have traditionally been highly productive fishing grounds.

Activity One: Exploration

Brainstorm:

- "What do animals need to survive?"
- "Fish are animals. What do they need to survive in the open ocean?"
- "How do fish get food?"

Have your students research current world ocean fishing patterns and develop a complete world map. Using this map, ask the students to determine where most fish are caught and what is unique about these areas.

Activity Two: Concept Development

Trophic Levels: Math Problem

One way to show trophic levels is in the form of a pyramid. This shape is not correct for all ocean areas, but it shows how the system works. Draw a pyramid with a human at the top and phytoplankton at the base. The pyramid should represent the sea life needed to support one human who is eating 1 kg. of fish each day from the fourth trophic level. Remembering that only 10% is passed from one level to the next, calculate the weight of small fish at the third trophic level, weight of zooplankton at the second trophic level, and weight of phytoplankton at the first trophic level that are needed to support this “pyramid.”

Activity Three: Application & Assessment

Some people believe that large-scale fishing should be limited to areas where the target fish are eating no higher than the third trophic level. Do you agree with this? Why or why not?

The majority of the food people eat comes from land (vegetables and meat). When we eat seafood, we often select large animals such as tuna and swordfish. Which type of food is more “efficient” in terms of the trophic level at which we are operating?

PART 2

How do upwelling zones form in the equatorial area?

BACKGROUND

Wind creates horizontal currents along the ocean surface (See Part 3). Under certain circumstances, these horizontal currents can cause vertical currents. For example, in the diagram below, wind is pushing ocean water at the surface toward a landmass. Some of the moving water will be turned to the left or right, but some will be forced downward. This process of water from the surface being pushed toward the bottom is known as **downwelling**. Since water at the surface is generally warmer and contains more oxygen, the effect of downwelling is to warm the deeper water and increase its oxygen content.

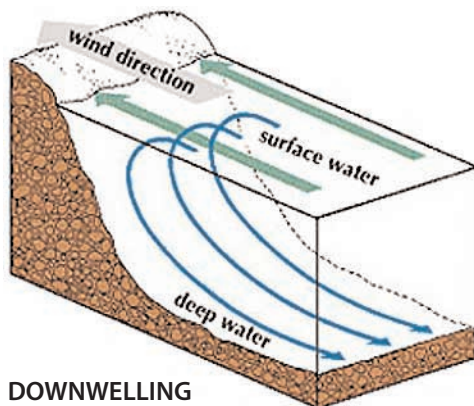

DOWNWELLING

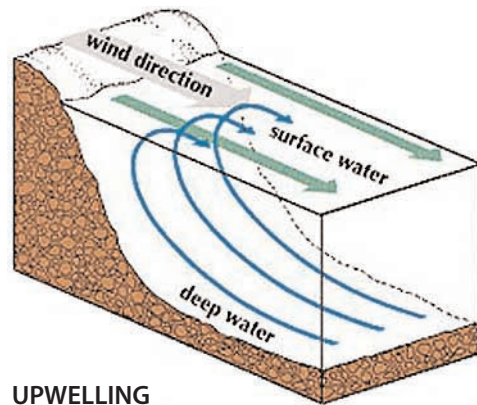

UPWELLING

The reverse of this process occurs when a surface current is forced to flow away from a landmass. Under these conditions water is drawn up from below in a process known as **upwelling**. Upwelling has a major biological significance because it brings nutrients from deep in the sea up to the surface waters. Upwelling can also affect the temperature of the water at the ocean’s surface. The water at the bottom is generally colder than the water above. When this cold water comes to the surface, it can impact local weather and climate.

When a large quantity of cold water is brought to the surface in an area of major upwelling, it can affect weather and climate across the entire globe. One example of this is the upwelling off the west coast of South America. When the Equatorial Current is flowing rapidly westward, away from the coast, it creates an upwelling that brings cold, nutrient-rich water to the surface. This water produces temperate weather and ample fishing. Sometimes the flow of the Equatorial Current slows, the upwelling decreases, and the surface waters become warmer and less rich in nutrients. This variation in the current is caused by what's called the **Southern Oscillation**, which produces the well-known El Niño and La Niña events.

A second type of upwelling occurs in areas of **divergence**, where two major ocean currents pull away from each other. As the currents diverge, the space between them is filled by water being pulled up from below. This major upwelling provides abundant nutrients to the local phytoplankton, and they in turn provide a rich feeding ground for animals such as baleen whales.

Activity One: Exploration

Place several centimeters of water in a long glass baking dish or similar tray and float small particles (for example, sawdust) on the water. Use a coffee cup water heater to warm the water at one end of the dish. As the water warms and the floating particles begin to move, ask the students to describe what they see and explain

what is happening. What is the source of energy? Ask if they can think of another way to produce a similar circulation using another source of energy.

Activity Two: Concept Development

Major currents such as the **Gulf Stream** flow about 5 kph. If you are measuring the Gulf Stream's flow at a point where the current is 100 km wide and 2 km deep, how many cubic meters of water will move past you in one hour? Most currents have a rounded shape, like half of a cylinder, but one that is as broad and as shallow as this can be treated like a rectangle.

$$(V = L \times W \times H)$$

Activity Three: Application & Assessment

Class Project: Design a way for your class to demonstrate what they have learned about upwelling to a group of students who do not yet know about it. (For example, they might use a fan blowing across water in which a blue, slightly saline layer lies below a clear, fresh layer. The speed of the fan would determine the amount of "cold" water brought to the surface.)

PART 3

What creates the winds that control El Niño?

BACKGROUND

Wind is air flowing across the Earth's surface. Winds are created by differences in atmospheric pressure that force air to flow from zones of higher pressure to zones of lower pressure. This is the same process that occurs when a leak in a balloon allows the air to flow from the **high pressure** inside the balloon to the lower pressure outside. On the Earth's surface, the differences in pressure are the result of unequal heating of the surface by solar energy. The

resulting wind patterns are primarily the result of both the **pressure gradient force** and the rotation of the Earth.

The most dramatic variation in the amount of solar energy reaching the Earth's surface is the difference between the amount of energy arriving at the equator and the amount arriving at the poles. This difference is due primarily to the angle at which the Sun's rays strike the Earth. In equatorial areas where the Sun's rays strike the surface nearly straight on (at about 90 degrees), the ground and water receive more heat per

area than in polar regions where the rays strike at more of an angle. As a result, the ground in equatorial areas is hotter and transfers more heat to the atmosphere above. Since the Earth is always trying to maintain an energy balance, heat is transported from warmer areas to cooler areas.

The density of air is related to temperature, such that warm air is less dense than cold air. On a large scale, this difference in density leads to the formation of zones of high and low atmospheric pressure, and on a smaller scale, it leads to the creation of local wind patterns. One of the most common examples of this is the sea breeze/land breeze in coastal areas. During the

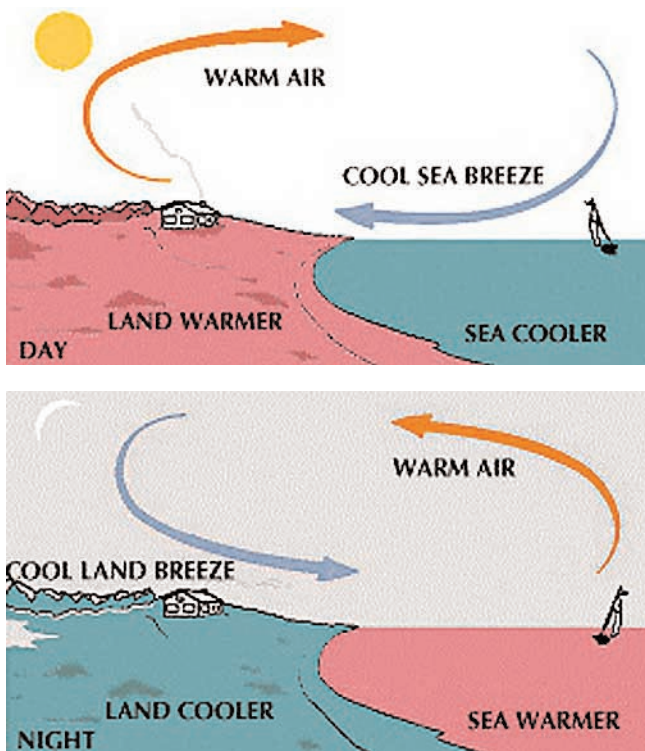

daytime, both the land and ocean absorb solar energy and become warmer. However, land areas warm significantly faster than ocean areas because water can absorb more heat than land without its temperature rising. As a result, more heat is transferred to the air over land than over water. When the warmer air over the land begins to rise, the rising air is replaced with cooler air from the ocean, and a sea breeze is established. In the evening the process is reversed. Because the land cools more rapidly than the water, the air over the water is soon warmer than the air over the land. As shown above, this creates a land breeze.

This same process also occurs on a worldwide scale. When the air in equatorial areas becomes warmer and less dense than the surrounding air, it rises to be replaced by air flowing in from other, cooler areas. In a similar way, the very cold air in polar areas sinks toward the surface because it is colder and more dense than surrounding air. This process should establish a large convection cell in which cold, dense air sinks toward the Earth's surface at the poles, becomes warmer as it moves over the surface toward the equator, and finally rises when it has become warm and less dense at the equator. This flow, named the **Hadley circulation**, is the way things might work were it not for the rotation of the Earth.

As air moves over the surface of the Earth it is diverted from its original path due to the Earth's rotation. This phenomenon is known as the **Coriolis effect**. One way to understand this effect is to imagine looking at the Earth from space. Pretend you can see one person standing at the North Pole and another person standing on the equator. Through one rotation of the Earth, the person on the equator will travel approximately 40,000 kilometers in a counterclockwise direction. Since this is accomplished in 24 hours, the person is traveling at a speed of over 1,600 kilometers (about 1,000 miles) per hour. In comparison, the person at the pole merely turns once around in place, not traveling any distance at all. In fact, the speed that the Earth's surface rotates gradually decreases from about 1,600 kph at the equator to zero at each pole. Air that starts out in contact with the Earth's surface at each of these spots is moving in a similar manner.

Now consider a mass of warm air rising at the equator and beginning to move toward the North Pole. Even as the air moves north, it will tend to rotate counterclockwise at the same speed the ground below was rotating where it started—at the fast-moving equator. That means, as the air moves north, it will be rotating relatively fast, while the Earth below rotates slower and slower. Relative to the Earth, the air begins to move east as well as north. In effect, the motion of the air is being diverted to the right of its original path. Worldwide, this phenomenon (known as the Coriolis effect) deflects all large-scale motions in the northern hemisphere to the right of their original course, and all motions in the southern hemisphere to the left. This effect divides the Earth's surface winds into three major cells or **wind belts** within each hemisphere: the

easterly trade winds prevail in an area extending from the equator to a latitude of about 30 degrees north or south. The **westerly winds** prevail from 30 degrees to about 60 degrees, and the **polar easterlies** dominate the area from 60 degrees to the pole. In examining the El Niño effect, the easterly trade winds are the most significant.

EASTERLY TRADE WINDS

The name **trade winds** is based on an early meaning of the word “trade,” *steady track*. The steady track of these winds comes from the stable weather conditions in tropical areas. Strongly heated air along the equator forms one side of an atmospheric cell that extends to about 30 degrees north of the equator. A similar cell exists south of the equator. Within each cell, the hot, less dense equatorial air rises and begins to move poleward. This air is replaced by cooler air that is drawn in along the surface from higher latitudes. In both cases, the moving air is affected by the Coriolis effect.

In the northern hemisphere, the air that is rising and moving toward the north is deflected to the right of its course and begins to move in a more easterly direction. By the time the moving air has reached a latitude of 30 degrees, it has been diverted entirely toward the east, and its progress toward the pole has been stopped. At this point, the air has been cooled, and since it is now more dense, it begins to sink back toward the surface. The air below is being drawn toward the equator to replace the rising hot air. As the air moves along the surface, it is also subject to the Coriolis effect, and in the northern hemisphere, its movement toward the equator is deflected to the right, or west. By the time this air reaches the equator, it has been diverted completely so that it is blowing directly toward the west.

In the southern hemisphere, diversion to the left has had the same effect so that the wind on both sides of the equator is blowing toward the west. Remember, winds are named in relation to the direction from which they come. So, a wind blowing toward the west, is an “east” wind.

The result of this circulation, driven by equatorial heat, is a large cell in the atmosphere in which the air rises at the equator and is diverted toward the east as it moves poleward. The air’s progress is stopped at 30 degrees latitude where it begins to fall back toward

the Earth’s surface and move back toward the equator. Once again, the Coriolis effect diverts the motion such that the air moves toward the west, creating a belt of easterly trade winds as the air moves through the tropics and ultimately becomes part of a strong and continuous wind blowing to the west along the equator.

Activity One: Exploration

Help each student to build a simple weather vane. Take the class outside with a compass and find obvious markers such as large trees, chimneys, or radio towers to mark the primary compass direction. If possible, allow students to take a compass home for the same purpose. Using these points, ask the students to record the direction from which the wind is blowing each morning at the start of school and each afternoon when they go home. Use the students’ data to see if there is a prevailing wind direction in your area.

Activity Set Two: Concept Development

● Simple Weather Activities

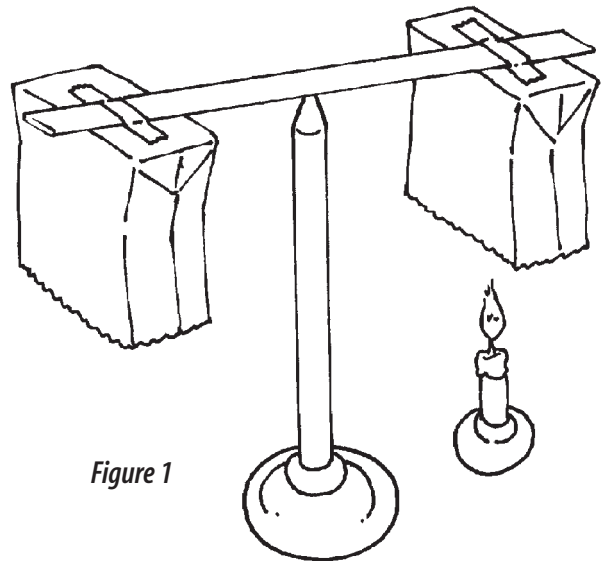

Figure 1

HOT AIR

Set up a meter stick with a paper bag taped to each end with the open end of the bag facing downward (See Figure 1). Balance the stick in the center and then either light a match or candle or turn on a heat source under one bag, being careful not to set the bag on fire. What happens? Why?

(NOTE: Be careful when using heat source. Be sure to remove when done.)

SURFACE HEATING

Set up five small trays—one containing wet sand, one dry sand, one wet charcoal, one dry charcoal, and one water. Place a thermometer in each, and warm all five with a heat lamp. Record the temperature at the start and at 1, 3, and 5-minute intervals. Turn off the lamp and record the temperature of each at 1, 3, and 5-minute intervals. Which material heated the most rapidly? Which heated the most slowly? Which cooled the most rapidly? How does this relate to actual Earth materials?

AIR PRESSURE

Stretch a balloon over the mouth of a small flask and attach a drinking straw to the rubber, creating a pointer (See Figure 2). Heat the flask in warm water and note the motion of the pointer. Do the same in cold water. Other than a change in temperature, what sort of change could make the pointer move?

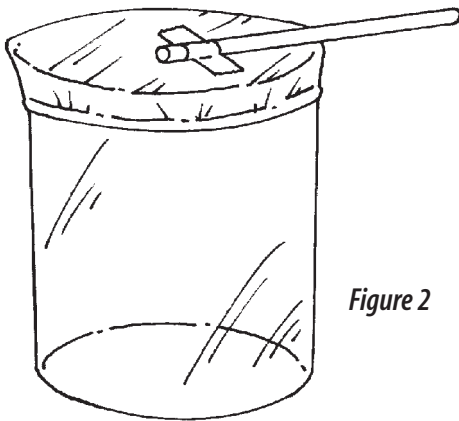

Figure 2

Use the information collected to talk about the motion of air and the origin of land and sea breezes. Point out that the **barometer** made above shows where the air is rising, creating low-pressure zones, or falling, creating high-pressure zones. Winds would blow directly from high pressure to **low pressure** were it not for the Earth's rotation.

● Differential Heating Activity

Have one student shine a flashlight directly (at a 90-degree angle) onto a piece of graph paper from a distance of 20 centimeters. A second student outlines the brightest part of the illuminated area on the graph paper with a pencil. A third student counts the number of squares, estimating the partial squares. How many squares were illuminated? Now have the person

with the flashlight shine it onto a piece of graph paper at an angle of approximately 45 degrees, from a distance of 20 cm. The second person outlines the brightest part of the illuminated area on the graph paper with a pencil, and the third person counts the number of squares. How many squares were illuminated? Now have the person with the flashlight shine it onto a piece of graph paper at an angle of approximately 15 degrees, from a distance of 20 cm. The second person outlines the brightest part of the illuminated area on the graph paper with a pencil, and the third person counts the number of squares. How many squares were illuminated? Which of the three setups received the most light? Explain your answer. Ask: In which of the three setups was the light most spread out? Ask: In which of the three setups was the light most intense? Ask: If instead of light, we were able to focus heat onto the paper, in which setup would the paper have become hottest?

● Coriolis Effect Activity

Using an old record turntable with a piece of white paper on its surface, ask a student to draw a "straight" line from the edge to the center, while the turntable is rotating slowly. The line will be a curve to the right of its intended course. Why couldn't the student draw a straight line? Explain how winds move from cooler, high latitudes (where air descends to form high-pressure areas) to warmer, low latitudes (where air rises to form low-pressure areas), and that this motion of the air is similarly affected by the rotating Earth, causing the air to move to the right in the northern hemisphere and to the left in the southern hemisphere.

Activity Three: Application & Assessment

1. Research and locate NASA CERES data to help locate areas of **differential heating** on the Earth. Speculate on the direction air might be moving in these locations.
2. Using NASA QuikSCAT wind pattern data, decide on the best path to sail a boat from Florida to England. Would you come back the same way?
3. Using a world map, select specific locations and ask the students to predict the prevailing winds. Ask them to explain their predictions.

PART 4

How do winds affect the ocean?

BACKGROUND

The ocean's major surface currents may be seen as distinct, fast-moving streams of warm or cold water that flow across the ocean's surface. The Gulf Stream, for example, brings warm water northward along the eastern coast of North America; and it eventually moves that water eastward across the North Atlantic to warm the climate of Great Britain and northern Europe. As early as 1770, Benjamin Franklin prepared a chart of the Gulf Stream as an aid to mail ships traveling between America and Europe. The upwelling offshore of California brings cold water southward along the coast of northern California and chills the waters near San Francisco, cooling its climate. These and other currents are portions of large circulations, or gyres, of water that are driven by the Earth's major wind belts and modified by the Coriolis effect and the presence of major landmasses. Surface currents have a significant effect on many things that are important to humans. As mentioned above, warm and cold water along our coastlines have a significant effect on climate, and ocean currents affect the processes that bring nutrients to the ocean's surface. Without the actions of surface currents, the ocean's ability to support life would be severely limited.

The background material in Part 3 described the origin of winds in the area between the equator and 30 degrees north and south latitude. As these winds approach the equator, they become easterly winds that blow parallel to the equator. As demonstrated in Part 2, this wind can slowly move the water in the same direction it is blowing. This creates currents that are usually shallow, less than a kilometer deep, and several hundred kilometers wide. They move much more slowly than the wind that has created them but still progress at several kilometers per hour. Since the major wind belts generally move the air in easterly or westerly directions, the surface currents they produce in the ocean would be belts of water moving in the same direction, were it not for the interference of the landmasses.

The surface currents being driven by easterly winds at the equator, and westerly winds at higher latitudes,

eventually encounter masses of land and are diverted toward the north or south. The way in which the currents are diverted depends on the size and shape of the landmasses they meet. For example, the equatorial current moving westward toward the Americas is easily diverted to the north when it encounters the east coast of South America. Moving northward, the current becomes the Gulf Stream. Similarly, when the large current known as the North Atlantic Drift moves eastward across the North Atlantic and encounters Ireland and Great Britain, it is divided into two parts. One portion of the current continues northward along the western and northern coasts of Norway and Sweden, and a portion is turned to the south to become the Canary Current flowing southward along the west coast of Europe. Currents in the other oceans are similarly divided and diverted by landmasses. The ultimate effect is that currents forced to flow in an east/west direction by the major wind belts are turned by landmasses so as to continue to the north and south. Eventually, the flow of each major current is turned to form a large circulation around each ocean basin. The equatorial portion of each gyre is a strong current moving to the west along the equator.

Activity One: Exploration

Research sources of NASA TRMM Sea Surface Temperature (SST) data and maps. Find areas of the ocean that are colder than would be expected. Suggest several explanations for this. If SST maps can be found for several time periods, suggest reasons why the "cold" areas have changed in size and location.

Activity Two: Concept Development

What's missing?—Students are presented with incomplete current maps and are asked to fill in the missing pieces. How do you know which way the missing currents should flow?

Activity Three: Application & Assessment

What's going on here?—Research NASA CERES data sources that might be used to predict ocean current direction. Or use drift-buoy data to predict general ocean water temperatures.

PART 5

Can the use of satellite data improve your fishing results?

The students prepare a presentation for the investors, showing the significant advantage that your fishing company has because it uses TRMM data and information from other satellites to locate fishing areas.

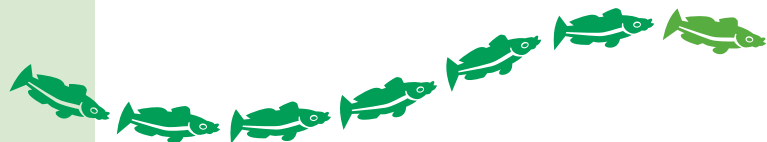
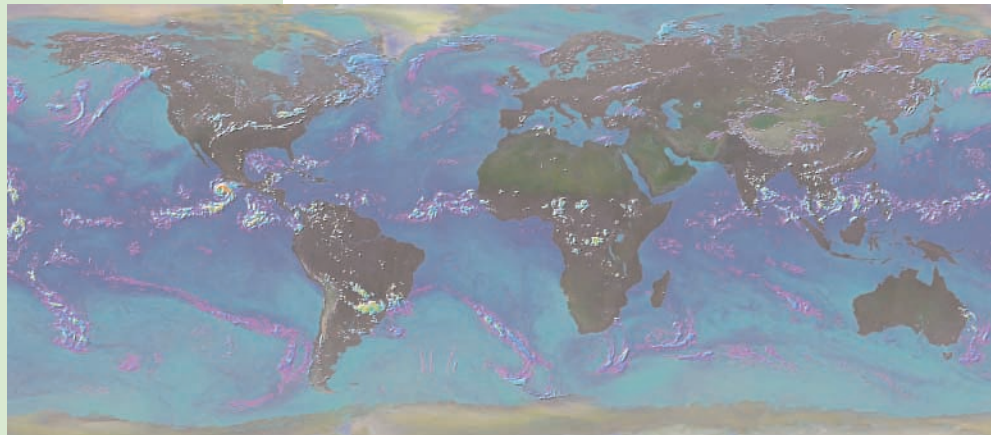

APPENDIX A

Bibliography

Center for Science Education—University of South
Carolina, *High School Earth & Environmental Science
Materials Online*, Columbia, SC: 1999

Compton's *NewMedia, Inc.*, 1995

Miller, Albert & Thompson, Jack, *Elements of
Meteorology, 3rd Edition*, Columbus, OH: Charles E.
Merrill, 1979

Miller, G. Tyler, *Living in the Environment, 10th Edition*,
Belmont, CA: Wadsworth, 1998

Williams, Jack, *The Weather Book, 2nd Edition*, New York:
Random House, 1997

APPENDIX B

Assessment Rubric & Answer Keys

SKILL	Extensively	Frequently	Sometimes	Rarely
Participates in class activities and discussions				
Collects relevant data and uses it to solve problems				
Presents findings and solutions clearly in appropriate formats				
Demonstrates ability to locate relevant information on appropriate Internet sites				
Makes appropriate connections between topics investigated and major concepts about winds				
Can draw data and findings together in a presentation that demonstrates an overall understanding of the topic				

Answer Keys: Part 1

Activity One: Exploration

- "What do animals need to survive?"
Students might suggest: shelter, food, mates, ways to avoid predators, etc.
- "Fish are animals. What do they need to survive in the open ocean?"
Food may be the only important item remaining.
- "How do fish get food?"
They eat smaller fish or plants.
- Using a world map showing ocean fishing results, ask the students to decide where most fish are caught. Is there anything unique about these areas?
For the equatorial areas, the map should show that the most productive fishing is off the western coasts of South America and Africa. Outside of the tropics, fishing is successful in areas of ocean divergence around Antarctica and in the shallow areas over the banks in the North Atlantic. All of these locations are places where nutrients are particularly abundant in the surface waters.

Activity Two: Concept Development

- Trophic Levels: Math Problem:
Calculate the weight of small fish at the third trophic level, (10 kg); weight of zooplankton at the second trophic level (100 kg); and weight of phytoplankton at the first trophic level (1,000 kg – 1 metric ton) that are needed to support this "pyramid."

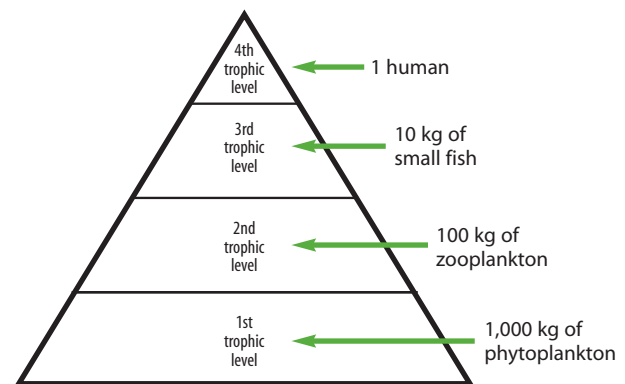

Answer Keys: Part 2

Activity One: Exploration

- What is the source of energy?
The warmed water is rising from the bottom and displacing water at the surface. The energy is heat.
- Ask if they can think of another way to produce a similar circulation using another source of energy.
Another way would be to blow wind over the surface, producing a small upwelling.

Activity Two: Concept Development

- How many cubic meters of water will move past you in one hour?
Length: 5 km (the flow for one hour) x Width: 100 km x Height: 2 km = Volume: 1,000 km³.
(One km³ contains 1 billion m³)
Answer: One trillion cubic meters of water.

Answer Keys: Part 3

Activity Set Two: Concept Development

Simple Weather Activities

HOT AIR

What happens? Why?

The heated bag will rise because the molecules in the heated air have gained energy and begun to move about more rapidly. This occupies more space, making the air less dense. Less dense air rises. Air can be made less dense by heating it or by increasing its content of water vapor. Water vapor (H₂O) is less dense than O₂ or N₂.

SURFACE HEATING

Which material heated the most rapidly?

Dry sand and dry charcoal

Which heated the most slowly?

Water

Which cooled the most rapidly?

Dry sand and dry charcoal

How does this relate to actual Earth materials?

Dry areas on land will heat faster than lake or ocean areas; as a result, they become warmer during the day. Land areas will cool faster than water areas; as a result, they become cooler at night. When the ground warms the air directly above it, the air over the land will tend to be warmer and rise during the day; and the air over the water will be warmer and rise at night.

AIR PRESSURE

Heat the flask in warm water and note the motion of the pointer. Do the same in cold water.

Warm water will heat the air in the flask, making the balloon rise and the pointer move downward. The **air pressure** outside the flask is lower than the air pressure inside. The reverse is true when the flask is cooled.

Other than a change in temperature, what other sort of change could make the pointer move?

A change in atmospheric pressure would make the pressure outside the flask higher or lower and make the pointer move.

Differential Heating Activity

- *How many squares were illuminated? Which of the three setups received the most light? Explain your answer.*

In all three setups, the same amount of light struck the paper.

- *Ask: In which of the three setups was the light most spread out?*

The light was most spread out when the flashlight was held at a 15-degree angle.

- *Ask: In which of the three setups was the light most intense?*

The light was most intense when the flashlight was held perpendicular to the paper, because the same amount of light was spread over a smaller area.

- *Ask: If instead of light, we were able to focus heat onto the paper, in which setup would the paper have become hottest?*

The paper that was perpendicular to the heat rays would have become hottest. This relates to the tilt of the Earth creating warm and cold areas on the surface. The equator is a warm area where air tends to rise. The higher latitudes are cooler, allowing air to sink. These motions are the beginning of the Earth's major wind bands.

APPENDIX C

National Education Standards

SCIENCE

Content Standard: K–12

Unifying Concepts and Processes

Standard: As a result of activities in grades K–12, all students should develop understanding and abilities aligned with the following concepts and processes:

- Systems, order, and organization
- Evidence, models, and explanation
- Constancy, change, and measurement

Content Standards: 5–8

Science as Inquiry

Content Standard A: As a result of activities in grades 5–8, all students should develop:

- Abilities necessary to do scientific inquiry
- Understandings about scientific inquiry

Physical Science

Content Standard B: As a result of activities in grades 5–8, all students should develop an understanding of:

- Motions and forces
- Transfer of energy

Earth and Space Science

Content Standard D: As a result of activities in grades 5–8, all students should develop an understanding of:

- Structure of the Earth system

Science and Technology

Content Standard E: As a result of activities in grades 5–8, all students should develop:

- Understandings about science and technology

Science in Personal and Social Perspectives

Content Standard F: As a result of activities in grades 5–8, all students should develop an understanding of:

- Populations, resources, and environments
- Risks and benefits
- Science and technology in society

National Research Council. 1996. National Science Education Standards p. 115, 143–171. Washington, DC: National Academy Press.

MATH

Curriculum Standards for Grades 5–8

Standard 1: Mathematics as Problem Solving

Standard 2: Mathematics as Communication

Standard 3: Mathematics as Reasoning

Standard 4: Mathematical Connections

Standard 7: Computation and Estimation

Standard 9: Algebra

Standard 10: Statistics

Standard 11: Probability

National Council of Teachers of Mathematics. 1989. Curriculum and Evaluation Standards for School Mathematics p. 63–119. Reston, VA: The National Council of Teachers of Mathematics, Inc.

GEOGRAPHY

National Geography Standards for Grades 5–8

The World in Spatial Terms

Standard 1: How to use maps and other geographic representations, tools, and technologies to acquire, process, and report information from a spatial perspective.

Standard 3: How to analyze the spatial organization of people, places, and environments on Earth's surface.

Places and Regions

Standard 4: The physical and human characteristics of places.

Physical Systems

Standard 7: The physical processes that shape the patterns of Earth's surface.

Standard 8: The characteristics and spatial distribution of ecosystems on Earth's surface.

Environment and Society

Standard 15: How physical systems affect human systems.

American Geographical Society, Association of American Geographers, National Council for Geographic Education, and National Geographic Society. 1994. Geography for Life: National Geography Standards p. 143–182. Washington, DC: National Geographic Research and Exploration.

ENGLISH LANGUAGE ARTS

Standard 1: Students read a wide range of print and nonprint texts to build an understanding of texts, of themselves, and of the cultures of the United States and the world; to acquire new information; to respond to the needs and demands of society and the workplace; and for personal fulfillment. Among these texts are fiction and nonfiction, classic and contemporary works.

Standard 4: Students adjust their use of spoken, written, and visual language (e.g., conventions, style, vocabulary) to communicate effectively with a variety of audiences and for different purposes.

Standard 5: Students employ a wide range of strategies as they write and use different writing process elements appropriately to communicate with different audiences for a variety of purposes.

Standard 7: Students conduct research on issues and interests by generating ideas and questions, and by posing problems. They gather, evaluate, and synthesize data from a variety of sources (e.g., print and nonprint texts, artifacts, people) to communicate their discoveries in ways that suit their purpose and audience.

Standard 8: Students use a variety of technological and informational resources (e.g., libraries, databases, computer networks, video) to gather and synthesize information and to create and communicate knowledge.

Standard 12: Students use spoken, written, and visual language to accomplish their own purposes (e.g., for learning, enjoyment, persuasion, and the exchange of information).

National Council of Teachers of English and International Reading Association. 1996. Standards for the English Language Arts p. 24–46. Urbana, Illinois and Newark, Delaware: National Council of Teachers of English and International Reading Association.

SOCIAL STUDIES

Strand 3: People, Places, and Environments. Social Studies programs should include experiences that provide for the study of people, places, and environments.

Strand 5: Individuals, Groups, and Institutions. Social Studies programs should include experiences that provide for the study of interactions among individuals, groups, and institutions.

Strand 7: Production, Distribution, and Consumption. Social Studies programs should include experiences that provide for the study of how people organize for the production, distribution, and consumption of goods and services.

Strand 8: Science, Technology, and Society. Social Studies programs should include experiences that provide for the study of relationships among science, technology, and society.

National Council for the Social Studies. 1994. Expectations of Excellence: Curriculum Standards for the Social Studies p. 19–30. Washington, DC: National Council for the Social Studies.

Problem-Based Learning

What is Problem-Based Learning?

The Problem-Based Learning (PBL) model of teaching is a lot like it sounds; students learn by solving a problem. While this occurs in all classrooms to a different extent, the PBL learning model causes a drastic shift in the roles of students and teachers. In traditional teaching methods, the teacher acts as director of student learning, which is commonly passive. With PBL, these roles shift. Students become active and responsible for their own learning, and the activity is student-centered; the teacher becomes more of a facilitator or guide, monitoring student progress.

By using this model, the students gain information through a series of self-directed activities in which the students need to solve a problem. These problems drive the learning process and are designed to help students develop the skills necessary for critical thinking and problem solving. Students learn that in the real world, problems, and their solutions, are not always cut and dried, and that there may be different possible answers to the same problem. They also learn that as they continue to gain information, they need to readjust their plan. In other words, they must perform self-assessment.

A PBL lesson starts with a problem posed directly to the students. These problems are poorly structured to reflect real-world situations. Students (most commonly in small, cooperative groups) are then left to determine what steps need to be taken in order to solve the problem. The teacher does not give the students the information needed prior to the activity. However, the teacher does need to make sure the students have enough prior knowledge to be able to interpret the problem and determine a plan of action.

A key component of PBL is constant feedback. While the students are constantly assessing their work, and in turn adjusting their plan, teachers also need to provide continual, immediate feedback. Without feedback, students may be uncomfortable with this type of activity, because they do not know what is expected of them. Teacher feedback provides reinforcement for student learning. Feedback should be an authentic, performance-based assessment. Students need to

continually evaluate their contributions. Rubrics provide a good guide for both teachers and students, to ensure that the students are continually kept on the right track.

Why use PBL?

Traditional teaching methods focus on providing students with information and knowledge. The PBL model also adds “real-world” problem-solving skills to the classroom. It teaches students that there is sometimes more than one possible answer, and that they have to learn how to decide between/among these answers.

Students and PBL

Students are broken up into groups and are presented with a poorly structured, complex problem. Students should have enough background knowledge to understand the problem, but should not be experts. Any one, specific solution to the problem should not be evident. The students will need to determine what the problem is that they need to solve. Some organizational questions they may ask themselves are:

- What do we know about this problem?
- What do we need to know?
- How/where do we get the information needed to solve the problem?

The next step for the students is to determine a problem statement. From the information given to them in the problem, they should determine what they need to know and then plan a course of action to get the information they need to propose a solution. In implementing this plan, they will have to gather information to help them solve the problem. They will need to be sure that the resources they use are current, credible, accurate, and unbiased. As information is gathered and interpreted, they then apply their new knowledge, reevaluate what they know, and redetermine what they need to know to solve the problem. Once all the information is gathered, interpreted, and discussed, the group works together to propose a final solution.

Benefits of PBL

By using the Problem-Based Learning method, students gain more than just knowledge of facts. They develop critical thinking skills while working in collaborative groups to try to solve a problem. In doing this, they learn how to:

- interpret the question/problem,
- develop a problem statement,
- conduct research, reevaluating prior knowledge as new knowledge is gained,
- determine possible solutions, and
- pick the best possible solution based on the information they have gathered.

By providing immediate student feedback, the students can continually readjust their thinking, correcting any misconceptions or errors before moving on.

By using PBL, students become more familiar with “real-world” problems. They learn that there is not always only one correct answer, and that they need to work together to gather enough information to determine the best solution.

The PBL Classroom

When using the PBL model of instruction, it is best for students to work in small cooperative groups. The objective of this model is for students to work in a collaborative setting where they can learn social and ethical skills to determine how to answer the question presented. Students are expected to regulate themselves while in these working groups.

PBL Assessment

As the student groups work together to collect information, they will need to constantly assess their own progress and readjust their plan. As they do this, they will need continual, immediate feedback from the teacher. When they become more comfortable with this model, they will learn to rely less on the teacher and become more independent. By providing the students with the grading rubric, it will serve as a guide to ensure they are on the right track throughout the activity.

TRMM Introduction/Instruments

Introduction to the Tropical Rainfall Measuring Mission (TRMM)

Rainfall is one of the most important weather and climate variables that determine whether mankind survives, thrives, or perishes. Water is so ubiquitous on planet Earth that we often take it for granted. Too much water results in devastating floods, and the famine caused by too little water (drought) is responsible for more human deaths than all other natural disasters combined. Water comprises more than 75 percent of our bodies and as much as 95 percent of some of the foods we eat.

Water is essential to life, as it nourishes our cells and removes the waste they generate. Water determines whether plants produce food, or whether they wither from drought or rot from dampness. Water is essential to our homes and factories, to our production of food, fiber, and manufactured goods, and to just about everything else we produce and consume. Although water covers more than 70 percent of the Earth's surface, only about 3 percent is fresh water—and about 75 percent of that is inaccessible because it is locked up in glaciers and icecaps.

Another important aspect of rainfall, or any other precipitation, is its role in redistributing the energy the Earth receives from the Sun. Evaporation of water from the Earth's surface, condensation of water vapor into cloud droplets or ice particles, precipitation, runoff of the precipitation, and melting of snow and ice constitute what is known as the water cycle, or the hydrological cycle. Evaporation, the process of changing water from liquid to gas form, absorbs 540 calories of energy per gram of water; while simply raising the temperature of a gram of water one degree Celsius—without changing its phase—requires only one calorie of energy. Thus, much of the Sun's energy that reaches the Earth's surface is used to evaporate water instead of raising the temperature of the surface. The resulting water vapor is carried upward by the atmosphere until it reaches a level where it is cooled to its condensation

temperature. Then the water vapor releases the energy (540 calories per gram) it absorbed during the evaporation process. This “latent heat” release can occur thousands of kilometers from where the latent heat was originally absorbed.

Water plays an additional critical role in weather and climate: water vapor, it turns out, is the most abundant and most important greenhouse gas! Greenhouse gases trap some of the energy given off by the Earth's surface in the atmosphere. Therefore, the distribution and quantity of water vapor in the atmosphere are important in determining how well the Earth can emit the energy it absorbs from the Sun back into space. Unless the Earth loses as much energy as it receives, it will warm up. If the Earth loses more energy than it receives, it will cool down. The distribution of water vapor in the atmosphere also affects cloudiness; and clouds play an important role in determining how much solar energy reaches the Earth's surface, as well as how much heat can escape to space.

Perhaps it is now obvious that water, in all its forms, plays a critical role in determining what we call weather and climate. Our understanding of the complicated interactions involving water is insufficient to permit us to forecast, with much skill, weather beyond several days and climate beyond a few months. Because the occurrence of precipitation is highly variable in both time and space, and almost three-fourths of the Earth's surface has no rain gauges because it is covered by the oceans, we have never been able to adequately observe the global distribution of rain. Measurements from rain gauges on islands and satellite images of clouds have led to estimates of global precipitation. But TRMM—the first satellite to measure precipitation with the accuracy available from a radar in combination with other remote sensors—represents a breakthrough in our ability to monitor precipitation on a global scale.

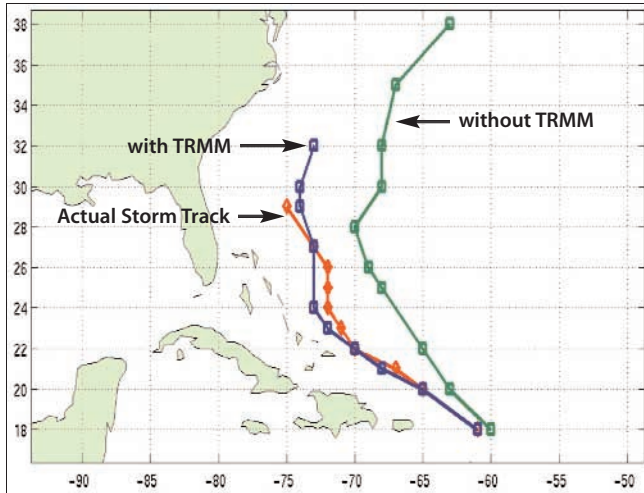

Hurricane Bonnie, August 1998: 5-Day Forecasts vs. Actual Storm Track

Improved forecasts can save money (\$600K–\$1M per mile of coast evacuated) and lives by more precisely predicting where the hurricane eye will be located at landfall. Source: Dr. A. Hou, NASA DAO

TRMM Instruments

TRMM Microwave Imager (TMI)

The TRMM Microwave Imager (TMI) is a passive microwave sensor that detects and images microwave radiation emitted by water droplets, ice particles, and the Earth's surface. TMI detects radiation at five different frequencies, which helps to distinguish between rainfall, bodies of water, and land. Data obtained from this instrument is used to quantify the water vapor, cloud water, and rainfall intensity in the atmosphere.

Precipitation Radar (PR)

The Precipitation Radar (PR), an active sensor, is the first space-based precipitation radar. PR emits radar pulses toward Earth, which are then reflected by precipitation particles back to the radar. By measuring the strength of the returned pulses, the radar is able to estimate rainfall rates. Among the three main instruments on TRMM, PR is the most innovative. Other instruments similar to TMI and the Visible and Infrared Scanner (VIRS) have operated in space before, but PR is the first radar launched into space for the purpose of measuring rainfall. Data obtained from this instrument:

- provides three-dimensional storm structures;
- helps to determine the intensity and three-dimensional distribution of rainfall over land and water,

which can be used to infer the three-dimensional distribution of latent heat in the atmosphere;

- provides information on storm depth; and
- provides information on the height at which falling snow or ice particles melt into rain.

Visible Infrared Scanner (VIRS)

The Visible and Infrared Scanner (VIRS) measures radiance in five wavelength bands (from visible to infrared) emitted by clouds, water vapor, and the Earth's surface. The intensity of radiation from a cloud corresponds with the brightness or temperature of the cloud, which in turn indicates the height of the cloud—brighter (colder) clouds are higher in altitude, and darker (warmer) clouds are lower. In general, higher clouds are associated with heavier rain. By comparing VIRS observations with rainfall estimates from TMI and PR, scientists are able to better understand the relationship between cloud height and rainfall rate, and can apply this knowledge to radiation measurements made by other weather satellites.

Cloud and Earth's Radiant Energy System (CERES)

The Clouds and the Earth's Radiant Energy System (CERES) measures the amount of energy rising from the Earth's surface, atmosphere, and clouds. Clouds can have both a warming and cooling effect on the Earth, trapping energy emitted by the Earth's surface while blocking energy from the Sun. Similarly, water vapor also warms the Earth by trapping outgoing radiation, but also condenses to form clouds that sometimes have a cooling effect. Data from this instrument helps scientists learn more about how the Earth distributes the energy it receives from the Sun, as well as the effects of clouds and water vapor on the overall temperature and energy budget of the Earth. This information will help long-term climate models make more accurate predictions.

Lightning Imaging Sensor (LIS)

The Lightning Imaging Sensor (LIS) is a powerful instrument that can detect and locate cloud-to-ground, cloud-to-cloud, and intra-cloud lightning. The information gained from this instrument is used to classify cloud types and, together with other TRMM instruments, to correlate lightning flash rate with storm properties, including rainfall rate. It's also expected that the information provided from LIS will lead to future advances in lightning detection and forecasting.

air pressure—The weight of the atmosphere over a particular point, also called barometric pressure. Average air exerts approximately 14.7 pounds (6.8 kg) of force on every square inch (or 101,325 newtons on every square meter) at sea level.¹

banks—The sloping ground that borders a stream and confines the water in the natural channel when the water level, or flow, is normal.²

barometer—An instrument used to measure atmospheric pressure.¹

consumers—Animals that feed on plants (primary consumers) or on other animals (secondary consumers).³

Coriolis effect—A force per unit mass that arises solely from the Earth's rotation, acting as a deflecting force. It is dependent on the latitude and the speed of the moving object. In the northern hemisphere, air is deflected to the right of its path, while in the southern hemisphere, air is deflected to the left of its path. It is greatest at the poles, North and South, and almost nonexistent at the equator.⁴

differential heating—Water and land heat up and cool off at different rates. Because water is a slow conductor of heat, it requires more energy than land to raise its temperature. Land requires less heat to raise its temperature, but loses its heat more quickly than water.⁵

divergence—Wind movement that results in a horizontal net outflow of air from a particular region. Divergence at lower levels is associated with a downward movement of air from aloft. Contrast with convergence, wind movement that results in a horizontal net inflow of air into a particular region. Convergent winds at lower levels are associated with upward motion.⁴

downwelling—The process of accumulation and sinking of warm surface waters along a coastline. A change of air flow of the atmosphere can result in the sinking or downwelling of warm surface water. The resulting reduced nutrient supply near the sur-

face affects the ocean productivity and meteorological conditions of the coastal regions in the downwelling area.⁶

easterly trade winds (easterlies)—Usually applied to the broad patterns of persistent winds with an easterly direction.⁴

food chain—Sequence of organisms in which each is food for the next member in the sequence.³

Gulf Stream—A warm, swift ocean current that flows along the coast of the eastern United States and makes Ireland, Great Britain, and the Scandinavian countries warmer than they would be otherwise.¹

Hadley circulation/Hadley cell—A thermal circulation proposed by George Hadley to explain the movement of the trade winds. It consists of rising air near the equator and sinking air near the 30° latitude.⁷

high pressure—An area of relative pressure maximum that has diverging winds that rotate clockwise in the northern hemisphere and counterclockwise in the southern hemisphere. Also known as an anticyclone, it is the opposite of an area of low pressure, or a cyclone.⁴

low pressure—An area of relative pressure minimum that has converging winds that rotate counterclockwise in the northern hemisphere and clockwise in the southern hemisphere. Also known as a cyclone, it is the opposite of an area of high pressure, or an anticyclone.⁴

nutrients—In the ocean, any one of a number of inorganic or organic compounds or ions used primarily to feed primary producers; nitrogen and phosphorus compounds are examples.³

photosynthesis—Manufacture by plants of organic substances and release of oxygen from carbon dioxide and water in the presence of sunlight and the green pigment chlorophyll.³

phytoplankton—Microscopic plants, which drift passively or swim weakly in fresh or salt water bodies.³

polar easterlies—A shallow body of easterly winds located at high latitudes, poleward of the subpolar low (a belt of low pressure located between 50° and 70° latitude).⁷

pressure gradient force—Change in pressure over distance, divided by the air density.⁸

producers—Producers always begin the food chain and, in the ocean, are generally algae.⁹

Southern Oscillation—A periodic reversal of the pressure pattern across the tropical Pacific Ocean during El Niño events. It represents the distribution of temperature and pressure over an oceanic area.⁴

trade winds—The winds that occupy most of the tropics and blow from the subtropical highs to the equatorial low.⁷

trophic level—The position of an organism in a food chain or food (trophic) pyramid.³

upwelling—The process by which water rises from a lower to a higher depth, usually as a result of divergence and offshore currents. It influences climate by bringing colder, more nutrient-rich water to the surface. A vital factor of the El Niño event.⁴

westerly winds (westerlies)—Usually applied to the broad patterns of persistent winds with a westerly direction. It is the dominant persistent atmospheric

motion, centered over the midlatitudes. Near the Earth's surface, the westerlies extend from approximately 35 to 65 degrees latitude, while in the upper levels they extend further toward the poles and toward the equator.⁴

wind belts—See diagram below.¹

zooplankton—Microscopic animals, which drift passively or swim weakly in fresh or salt water bodies.³

¹ *Looking at Earth From Space: Glossary of Terms*, 1993, NASA EP-302

² USGS Water Basics Glossary: http://sr6capp.er.usgs.gov/GIP/h2o_gloss

³ University of California at Santa Barbara Introduction to Oceanography Glossary: http://oceanography.geol.ucsb.edu/Student_Pages/Paul/glossary

⁴ The Weather Channel Home Page: <http://www.weather.com/glossary>

⁵ NASA's Passport to Knowledge, Live from the Storm: http://passporttoknowledge.com/storm/index_why.htm

⁶ The Earth Observatory Glossary: <http://earthobservatory.nasa.gov/Library/glossary.php3>

⁷ Ahrens, C. Donald. 1994. *Meteorology Today*. St. Paul, MN: West Publishing Company

⁸ Satellite Meteorology Glossary and List of Acronyms: <http://cimss.ssec.wisc.edu/satmet/glossary/glossary.html#gp>

⁹ Ocean Planet: <http://educate.si.edu/lessons/currkits/ocean/main.html>

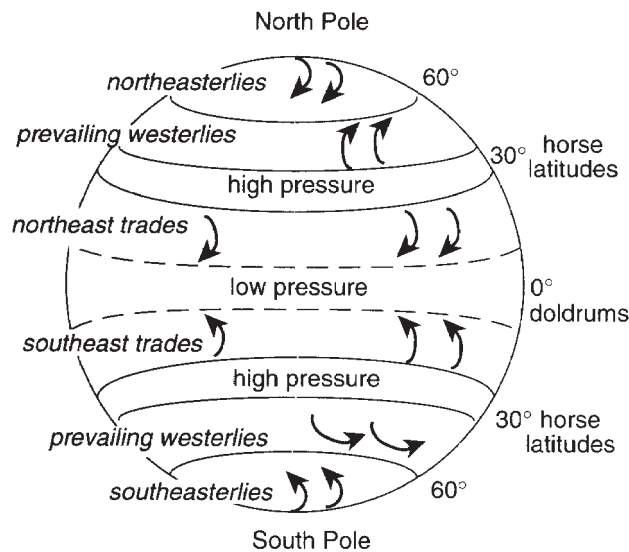

Earth's large-scale wind belts